



STREX

STREX Cell Strain Instrument

Catalog # STB-140-04

User Manual

Contents

Section 1: Main Components.....	3
Stretch Unit	3
Control Unit Front Panel	4
Control Unit Back Panel	4
Silicone Strain Chamber	5
Section 2: Use of the Cell Strain Instrument	6
Preparation of Cell Strain Instrument.....	6
System Operation	6
Culturing Cells in the Silicone Chambers.....	7
Preparation of Silicone Chambers.....	8
Section 3: Strain Parameters.....	10
Section 4: FAQ	11
Section 5: References	13
Section 6: Safety Instructions	15
Section 7: Warranty	18

Section 1: Main Components

Stretch Unit

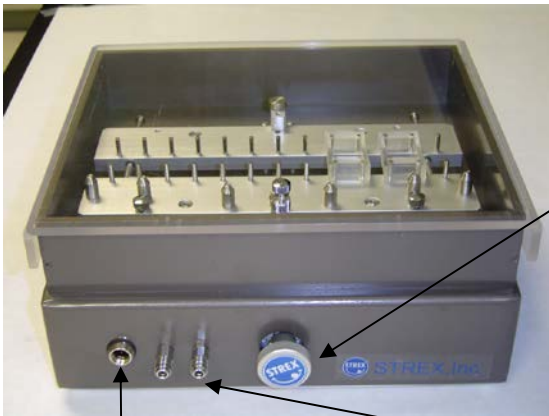

Chamber length adjusting knob:
Use the knob to adjust the distance of chamber brackets to maintain tension on the chamber. The bottom of the chamber should be taut.

System coolant inlet and outlet valves:
Be sure to supply cool water when in operation. Failure to do so may lead to overheating inside the incubator or motor burnout.

Connectors:
Use Connector Cable to connect Control Unit to Stretch Unit

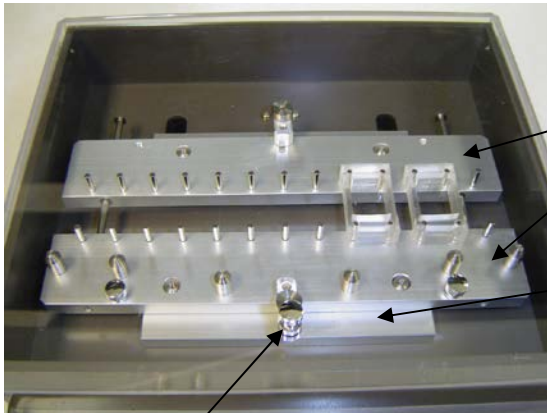

Strain Chamber Brackets:
Each chamber is mounted on four pins, two pins on each bracket.

Mounting Stage:
Brackets sit on top of the stage

Alignment Pins:
Holds Strain Chamber Brackets in place

Control Unit Front Panel

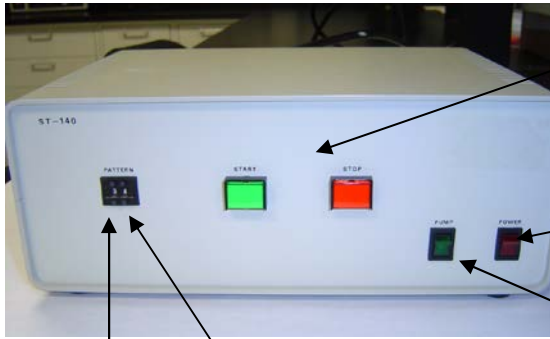

Start and Stop Button:

Use to start or stop the stretching action.

Main Power Switch

Water Pump Switch:

Use to turn on and off the pump that circulates water to cool the motor.

Strain Ratio:

Use upper and lower buttons to increase and decrease stretch ratio

Strain Frequency Selector:

Use upper and lower buttons to adjust cycle frequency.

Control Unit Back Panel

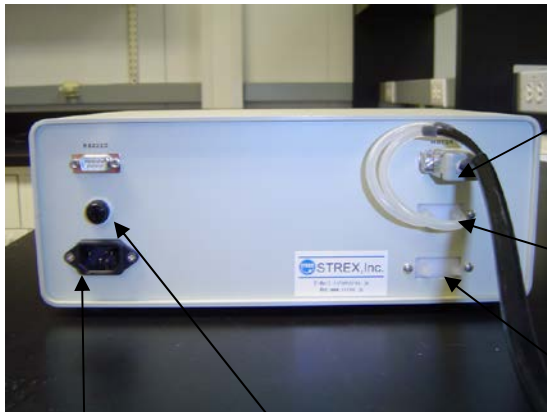

Control Connector:

This cable supplies electricity from the Control Unit to the Stretch Unit.

System coolant inlet & outlet valves:

Be sure to supply cool water when in operation. Failure to do so may lead to overheating inside the incubator or motor burnout.

Fuse case cover

Power Cable Outlet for 110 Volts:

Use the Power Cable to connect the Control Unit to a power source.

Reservoir coolant inlet & outlet valves:

Attach a large flask or similar type of reservoir filled with cold water.

Silicone Strain Chamber (ST-CH-04.0)

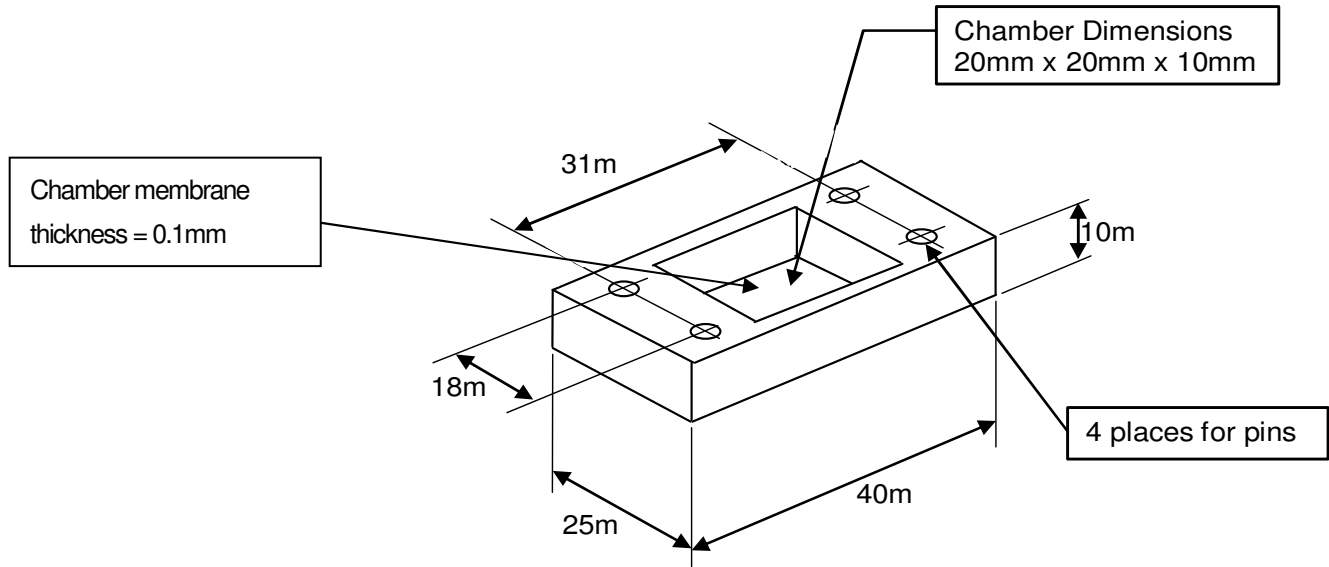

Section 2: Use of the Cell Strain Instrument

Preparation of the Cell Strain Instrument

Before using the Cell Strain Instrument, sterilize the unit — especially the chamber mounting area — using ethanol-immersed swabs.

System Operation

The STREX Cell Strain System needs to be water cooled when in operation. Without cooling, the maximum run time for the continuous operation of the motor is only 10 minutes. For longer operation, water cooling is essential. Also, please note that, when operating the unit in an incubator, the temperature inside the unit will be elevated so it is particularly important to ensure the cooling system is employed in this environment.

► Set up the Strain and Control Unit

1. Set up the cooling system by using the Connector Cable. The Connector Cable supplies electricity and cold water from the Control Unit to the Stretch Unit. One end of the Cable has 3 plugs of which 2 are identical metal plugs. This end of the Cable attaches to the front of the Stretch Unit. The 2 identical metal plugs are plugged into the System Coolant Inlet and Outlet Valves (see Section 1). To release the metal plugs from the Stretch Unit, push backward on the outer metal rings around the valves. The single, larger black plug supplies electricity to the Stretch Unit – this plug has to be in the correct orientation to fit properly.

The other end of the Connector Cable has 2 exposed latex tubes which fit onto the System Coolant Inlet and Outlet Valves on the back panel of the Control Unit. The Cable's square shaped plug fits the motor outlet just above the coolant valves.

To circulate cool water throughout the system, use latex tubing to attach a large reservoir of cold water to the Reservoir Coolant Inlet and Outlet Valves on the back panel of the Control Unit. The water in the reservoir can be kept cool by placing the reservoir on ice.

2. Use the Power Cable to connect the Control Unit to a 110 volt power source.
3. Turn on the Main Power Switch and Water Pump Switch on the Control Unit. The Switches will light up.
4. Press the START button to ensure that the strain chamber bracket moves correctly. The Start Button light will flash when the instrument is stretching.
5. Press the STOP button to ensure that the strain chamber bracket stops moving. The Stop Button will light up.

6. Make sure that the water pump is pumping water from the reservoir and through the Control and Stretch Unit.
7. Turn off Main Power and Water Pump Switches.

▶ Start Cell Stretching

1. **The Power Switch must be OFF to freely rotate the Chamber Length Adjustment Knob.** Silicone chambers containing cultured cells are attached to the Stretch Unit by inserting the 4 pins into the corners of the chamber. Rotate the Adjustment Knob clockwise until the bottom of the chamber is taut.
2. Select the stretch parameters by changing the Stretch Pattern Buttons. Refer to Section 3 for stretch parameters.
3. **Do not change the Strain Ratio or Strain Frequency Selector Buttons during the operation of a stretch cycle. Press the Stop Button and wait for the last cycle to complete and the chamber returns to its starting position before changing stretch parameters.** Changing parameters during a stretch cycle may damage the motors.
4. Push the Start Button to start the stretch unit.
5. After 5 minutes, stop the stretching and check the condition of the cells. If the cells have not detached, proceed with your experiment. If the cells are detached, the adhesion matrix coating was probably insufficient. Recoat the chambers.

Culturing Cells in the Silicone Chambers

1. Seed cells at the appropriate concentrations in the freshly coated chambers.

Important: It is critical to not over expose the cells to dissociation enzymes. Cells should be treated in the same manner (type, concentration of enzyme, temperature, and exposure time) for all experiments.

Important: Cells should not be cultured at a high cell density in the chambers. For example, epithelial cells often form a cell-sheet and the cell-cell adhesion seems to be stronger than a cell-surface adhesion. When this happens cells may detach from the chamber. Additionally, cultures that are grown over a week in the chambers may detach.

2. After overnight incubation, inspect cells under a microscope to ensure that they adhered to the chamber.

Preparation of Silicone Chambers

Before using the chambers, they should be sterilized then coated with a cell adhesion matrix. The coating procedures below can be adapted for use with other matrices, such as elastin, pronectin, and laminin.

Sterilize chambers in an autoclave for 20 minutes at 121 °C. The silicone chambers can withstand temperatures up to 180 °C. Use of an autoclave is preferable. However, if an autoclave is not available, the chambers may be sterilized by submerging in 70% ethanol, rinsing with water, then drying in a sterile environment.

Place the sterile silicone chambers in a Petri dish in preparation for coating.

► Fibronectin Coating

Preparation of fibronectin solution:

1. Dilute human or bovine fibronectin to a final concentration of 50 to 100 ug/ml in Phosphate Buffered Saline (PBS)

Coating with fibronectin solution:

1. Pour 3 ml of the fibronectin solution into each strain chamber
2. Incubate at 37°C for more than 30 minutes
3. Aspirate the fibronectin solution. If coating is successful, water will not be repelled after removing the fibronectin solution.
4. The liquid solution can be used to coat 3 or 4 chambers before discarding.

PBS (per liter):	
NaCl	8.00 g
KCl	0.20 g
Na ₂ HP ₄ (anhyd.)	1.15 g
KH ₂ PO ₄ (anhyd.)	0.20 g

Note: Dulbecco's PBS in powder form for tissue culture applications is also commercially available.

► Gelatin Coating

Preparation of gelatin solution:

1. Add gelatin powder to PBS at a concentration of 2%
2. Autoclave the mixture to dissolve and sterilize

Coating with gelatin solution:

1. Pour 3 ml of the gelatin solution into each strain chamber
2. Incubate at 37°C for more than 30 minutes
3. Aspirate the gelatin solution. If coating is successful, water will not be repelled after removing the gelatin solution.
4. The liquid solution can be used to coat 3 or 4 chambers before discarding.

► Collagen Coating (Cellmatrix 1-C, P, Type 3 or 4)

Preparation of collagen solution:

1. Combine 1 part collagen to 10 parts HCL, pH 3, in a sterile tube

Coating with collagen solution:

1. Coat chamber with a thin layer
2. Aspirate excess
3. Dry in biological safety cabinet at 25°C or below. The chamber can be stored at the same temperature.
4. Wash the chamber twice with culture medium.
5. If coating is successful, water will not be repelled.

The PDMS (silicone) chambers are very hydrophobic with two methyl-bases on the surface. Cells adhere to the fibronectin or collagen coated chambers via integrins. This form of cell adhesion is very different compared to attachment of cells to plastic or glass dishes where the surface of plastic or glass is charged, resulting in non-specific binding. If the cells are having difficulty attaching to the coated chamber or easily detached upon stretching, treat the stretch chamber with a higher concentration of fibronectin or collagen, for overnight.

Section 3: Strain Parameters (Stretch)

Customized for SDSU Bioengineering Lab

Left Digit: Strain Frequency Selector				Right Digit: Strain Ratio			
				Digit Degree of Stretch Distance		Custom Pattern	
0	60 cycles/min	Sine Wave	Stretch 0.5 sec - contract 0.5 sec - repeat	0	2%	0.4 mm	
1	30 cycles/min	Sine Wave	Stretch 1 sec - contract 1 sec - repeat	1	5%	1.0 mm	
2	90 cycles/min	Sine Wave	Stretch 0.33 sec - contract 0.33 sec - repeat	2	10%	2.0 mm	
3	60 cycles/min	Sine Wave	Stretch 0.67 sec - contract 0.33 sec - repeat	3	15%	3.0 mm	
4	60 cycles/min	Sine Wave	Stretch 0.75 sec - contract 0.25 sec - repeat	4	20%	4.0 mm	
5	60 cycles/min	Sine Wave	Stretch 0.85 sec - contract 0.15 sec - repeat	5	10-20%	2.0 to 4.0 mm	10-20%
6	1 cycle/min	Square Wave	Hold 29 sec - stretch 1 sec - hold 29 sec - contract 1 sec - repeat	6	10-15%	2.0 to 3.0 mm	10-15%
7	N/A	Static	Stretch 1 sec - hold indefinitely	7	5-15%	1.0 to 3.0 mm	5-15%

Section 4: FAQ

Q1: What are the characteristics of the silicone chamber?

A1: The strain chamber is made from silicone elastomer consisting of polydiethylsiloxane as its major component. The chamber surface is strongly hydrophobic and cells have difficulty attaching to it; therefore, the chamber surface should be coated with an extra-cellular matrix like fibronectin, collagen, laminin, or gelatin before cultivation.

Q2: Cell attachment on the stretch chamber is not consistent.

A2: There may be wrinkles or bubbles on the bottom surface of the strain chamber when seeding cells. Although the chamber is carefully made not to have wrinkles on it, some products might have little wrinkles due to its thin structure. We recommend the following steps. Place a small volume of ethanol in a Petri dish that is large enough to hold the strain chamber. Gently place the chamber in the culture dish starting at one edge and moving toward the opposite edge of the chamber to remove air bubbles between the dish and chamber. Allow the ethanol to evaporate before spreading your cell suspension in the chamber.

Q3. Cell attachment on the stretch chamber was confirmed by microscopy. But the cells detached from the chamber surface after stretching the cells.

A3: Try seeding your chambers at a lower concentration of cells. Over-confluent cells generally adhere to neighboring cells rather than to the base matrix (dish surface). When an excess amount of cells are put in a culture dish, the cells connect to each other after growth. Such behavior of the over-confluent cells, which are often observed in normal culture dishes, is even worse in the strain chamber.

A second possibility for cell detachment is that the cells were damaged by enzyme treatment such as trypsin before seeding. The damaged cells sometime attach to surfaces by non-specific binding and are not specifically bound to the extra-cellular matrix coating on the chamber; therefore, time, concentration, and temperature for the enzyme treatment should be optimized to reduce cell damage.

A third possibility is insufficient coating of the chamber preventing the cells from attaching to the chamber. Longer coating time is recommended. Some researchers coated the chamber with two or more kinds of the extra-cellular matrix materials to increase binding effectiveness.

Q4: How long can cells be stretched?

A4: The duration depends on cell strain and condition. In general, two weeks cultivation in the incubator is possible with culture media changes every 2-3 days. It is also important to monitor reservoir coolant for the instrument motor. Insufficient amount of the cooling water may increase the temperature of the motor resulting in killing of cells and /or burning out the motor.

Q5: How can I obtain protein or mRNA samples from the cells attached to the silicone membrane?

A5: (1) Proteins for Western blotting: Wash the cells once with PBS. Add SDS-PAGE sample loading dye directly into the chamber, and collect the cell extract by using a cell scraper.

(2) Proteins for Immunoprecipitation: Wash the cells once with PBS. Add cell extract buffer directly into the chamber, and collect the cell extract by using a cell scraper.

(3) RNA: Wash the cells once with PBS (for RNA preparation). Add RNA extraction buffer directly into the chamber, and collect the cell extract by using a cell scraper.

Q6: I want to use recombinant cells for an experiment.

A6: Direct transfection of cells in the strain chamber may be possible. However, transfection itself may damage the cells, which may make getting clear image data difficult. We recommend performing the transfection in a normal culture dish then transferring the recombinant cells into the strain chamber.

Q7: Cells seem to be crowded in the center of the chamber instead of being uniformly distributed throughout the chamber.

A7: Vibration from the incubator may disrupt the distribution of the cells. We recommend gently rocking the chamber 15 minutes after seeding your cells.

Section 5: References

1. Effects of repetitive stretch stimulation on neonatal rat cardiocytes in vitro, K. Kada, K. Yasui, K. Naruse, and J. Toyama. *Environmental Medicine*, 40: 69-72, 1996.
2. Inhibitory action of repeated stretch stimulation on apoptosis in neonatal rat cardiocytes., K. Yasui, H. Shimano, K. Kada, K. Naruse, and J. Toyama. *Environmental Medicine*, 40: 175-177, 1996.
3. Mechanosensitive ion channels: Single channels vs. Whole cell activities, M. Sokabe, K. Nunogaki and K. Naruse. *Progress in Cell Research*, 6:139-149, 1997.
4. Up-regulation of integrin beta3 expression by cyclic stretch in human umbilical endothelial cells., M. Suzuki, K. Naruse, Y. Asano, T. Okamoto, N. Nishikimi, T. Sakurai, Y. Nimura, and M. Sokabe. *Biophys. Biochem. Res.Com.*, 239:372-376, 1997.
5. Mechanotransduction and intracellular signaling mechanisms of stretch-induced remodeling in endothelial cells, Masahiro Sokabe, Keiji Naruse, Shorei Sai, Takako Yamada, Keisuke Kawakami, Masumi Inoue, Kichiro Murase and Motoi Miyazu. *Heart Vessel*, S12:191-193, 1997.
6. Involvement of SA channels in orienting response of cultured endothelial cells to cyclic stretch., K. Naruse, Y. Yamada, and M. Sokabe. *Am. J. Physiol.*, 274:H1532-H1538, 1998.
7. Up regulation of COX expression by uni-axial cyclic stretch in human lung fibroblast cells, T. Kato, N. Ishiguro, H. Iwata, T. Kojima, T. Ito and K. Naruse. *Biophys. Biochem. Res.Com.*, 244:615-619, 1998.
8. Pp125^{FAK} is required for stretch dependent morphological response of endothelial cells. K. Naruse, T. Yamada, X. Sai, M. Hamaguchi, and M. Sokabe. *Oncogene*, 17:455-463, 1998.
9. Orientation Change of Cardiocytes Induced by Cyclic Stretch Stimulation: Time Dependency and Involvement of Protein Kinases, K. Kada, K. Yasui, K. Naruse, and J. Toyama, *J. Mol. Cell. Cardio.*, 31:247-259, 1999.
10. Molecular Identification of a Eukaryotic Stretch-Activated Nonselective Cation Channel, M. Kanzaki, M. Nagasawa, I. Kojima, C. Sato, K. Naruse, M. Sokabe, H. Iida, *Science*, 285:882-886, 1999.
11. Activation of pp60^{SRC} is Critical for Stretch-Induced Orienting Response in Fibroblasts, X. Sai, K. Naruse, M. Sokabe, *J. Cell Sci.* 12:1365-1373, 1999.
12. SA Channel Mediates Superoxide Production in HUVECs, K. Aikawa, N. Nishikimi, T. Sakurai, Y. Nimura, M. Sokabe, K. Naruse, *Life Sci.* 69 (15):1717-1724, 2001.
13. Uni-axial cyclic stretch induces the activation of transcription factor nuclear factor κ B in human fibroblast cells, H. Inoh, N. Ishiguro, S. Sawazaki, H. Amma, M. Miyazu, H. Iwata, M. Sokabe, K. Naruse, *FASB Journal*, 16:405-407, 2002.
14. Mechanical stress-dependent secretion of interleukin 6 by endothelial cells after portal vein embolization: clinical and experimental studies, M. Kawai, K. Naruse, S. Komatsu, S. Kobayashi, M. Nagino, Y. Nimura, M. Sokabe, *J. Hepatol.* 37(2):240-246, 2002.
15. Calcium regulates the P13K-Akt pathway in stretched osteoblasts, T. Danciu, R. Adam, K. Naruse, M. Freeman, P. Hauschka, *FEBS Letters* 536:193-197, 2003.
16. A new mechanosensitive channel SAKCA and new MS channel blocker GsTMx-4, M. Sokabe, K. Naruse, T.

Qiong-Yao, *Folia Pharmacologica Japonica* 124(3):301-310, 2004.

17. Mechanotransduction of integrin is essential for IL-6 secretion from endothelial cells in response to uniaxial continuous stretch, A. Sasamoto, M. Nagina. S. Kobayashi, K. Naruse, Y. Nimura, M. Sokabe, *Am J Physiol Cell Physiol* 288:1012-1022, 2005.
18. N-cadherin-mediated cell adhesion determines the plasticity for cell alignment in response to mechanical stretch in cultured cardiomyocytes, T. Matsuda, K. Takahashi, T. Nariai, T. Ito, T. Takatani, Y. Jujio, J. Azuma, *Biochem Biophys Res Comm* 326:228-232, 2005.
19. N-cadherin signals through Rac1 determine the localization of connexin 43 in cardiac myocytes, T. Matsuda, Y. Jujio, t. Nariai, T. Ito, M. Yamane, T. Takatani, K. Takahasi, J. Azuma, *J Mol Cell Cardio* 40(4):495-502, 2006.
20. Activation of a mechanosensitive BK channel by membrane stress crated with amphipaths, *Mol Membr Biol* 22(6):519-527, 2005.
21. Stretch-induced cell proliferation is mediated by FAK-MAPK pathway, *Life Sci* 76(24):2817-2825, 2005.
22. Fabrication of reconfiguration protein matrices by cracking, X. Zhu, K. Mills, P. Peters, J. Bahng, El Liu, J. Shim, K. Naruse, M. Csete, M. Thouless, S. Takayama, *Nature Materials* 4:403-406, 2005.
23. Involvement of reactive oxygen species in cyclic stretch-induced NF- κ B activation in human fibroblast cells, H. Amma, K. Naruse, N. Ishiguro, M. Sokabe, *Brit J Pharmacol* 145:364-373, 2005.
24. Viscoelastic and dynamic nonlinear properties of airway smooth muscle tissue: roles of mechanical force and the cytoskeleton, S. Ito, A. Majumdar, H. Kume, K. Shimokata, K. Naruse, K. Lutchen, d. Stamenovic, B. Suki, *Am J Physiol Lung Cell Mol Physiol* 290(6):L1227-1237, 2006.
25. Bi-phasic activation of eNOS in response to uni-axial cyclic stretch is mediated by differential mechanisms in BAECs, H. Takeda, K. Komori, N. Nishikimi, Y. Nimura, M. Sokabe, K. Naruse, *Life Sci* 79(3):233-239, 2006.

Section 6: Safety Instructions and Precautions

Please read this section carefully before using the instrument. Items in this section alert the user to operational dangers that, if not followed, may damage the instrument or, more significantly, result in serious injury or death of the user. To ensure safe operation of the instrument, it is therefore imperative that you follow these instructions carefully.

Power cable

To avoid possible short circuit, shock, or fire



- Only use the power cable provided with the Cell Strain Instrument.
- Do not touch the cable with wet hands.
- Do not use the machine with other voltage than that specified. In some cases, a transformer may be used for compatibility. Inappropriate current may result in the machine overheating, short-circuiting, and/or fire may occur.
- Do not staple around the power cable.
- Do not bend the cable or place heavy objects on it.
- When pulling a connector from an outlet, pull to disconnect gently by holding its plug, not the cable.
- Do not plug many objects into a single electrical outlet since it may cause fire.
- If you are using an extension cord, ensure it can withstand the total current to be used.
- Disconnect power from the unit when it is not in use.
- Connect the instrument to a power-surge protected outlet.

Installation Location and Environment

- Keep the instrument on a stable, leveled floor or a table, secure from vibrations. Be sure you have enough space.
- Do not store the instrument in a humid or dusty place. Over time, excessive humidity or dust may cause deterioration that can result in an electrical short-circuit and possibly fire.
- Do not use the machine in a place where the temperature is excessively high. Do not place and run the machine near a heater or in a place being exposed to a direct sunlight.
- To avoid possibly explosion, never place and run the instrument nearby the presence of flammable solid substance, liquid, or gas. It may cause explosion or fire.
- Use the machine in well lit conditions.
- Do not use the machine outdoors in direct sunlight or rain, which may cause overheating or short circuit.

Safety Precautions

These Safety Precautions are to ensure that you use the product safely and correctly and to prevent harm or injury to users and other people. To prevent injury or harm please read and understand the below text.

 WARNING	Indicates handling prior to reading may cause serious injury or death.
 CAUTION	Indicates handling prior to reading may cause physical harm or damage.

Disclaimer

- We are not responsible for any damage to equipment or facilities during the installation, use, or removal of the product.
- We are not responsible for damages caused by earthquakes, thunder, wind, fire, flood, or a third party to the machine. Negligence, misuse, or abnormal conditions resulting in damage are also not our responsibility.
- We are not responsible for damages caused by malfunctions due to combinations of equipment or software not involving Strex.
- We are not responsible for any incidental damage caused by the use or misuse of this product including loss of business income, interruption of business, loss of stored data, theft of machine, etc.

WARNING

Please do not place water or water-containing vessels on or near the machine:

- Cups, vials, tubes etc. containing water should not be located on or near the device.
- Be careful as to not wet the connection cable or power cable. Failure to do so could lead to fire, electric shock etc. Do not disassemble or reconfigure.
- Do not attempt to disassemble or reconfigure this machine. Doing so may result in fire, electric shock, or equipment malfunction. Please do not use under abnormal conditions.
- If the machine is overheating, emitting a strange odor, etc. disconnect the power cable from the outlet immediately. Failure to do so may result in a fire or electric shock.
- Do not use voltage other than the indicated power supply voltage. Failure to do so may result in fire or electric shock. Be sure to use the supplied power cable.

- Do not exceed the rating of outlets and wiring equipment. If rating is exceeded with the multiple electrical components fire may be caused due to heat generation.
- Do not touch the main unit or the power cable during severe weather events. It may cause electric shock.
- Do not damage the power cable, forcibly bend it, twist it or pull it. Also, please do not place heavy or heated objects on the power cable. The power cable may be damaged, causing fire, electric shock accident, etc.
- Please contact your distributor to replace the power cable.
- Do not handle power cable with wet hands. Be aware of foreign matter entering instrument
- Unplug the machine immediately if foreign matter, such as water or excessive dust, is expected to have entered it to prevent risk of electric shock. If you dropped or damaged the machine.
- Unplug the power cable if the machine has been dropped or damaged. Not doing so may result in electric shock.

CAUTION

Proper Handling of This Equipment

- Do not place the power cable close to a heating source such as a hotplate or open flame. The cable cover may melt, causing fire, electric shock, malfunction, etc.
- When unplugging the power cable from the outlet, please do not pull on the cable part, but remove at the plug. Pulling the cable will damage the cable and cause fire, electric shock, breakdown, etc.
- Regularly check the condition of the plug. If it is damaged or if dust gathers in the plug insulation failure may result, causing fire. Also, if the plug is incompletely inserted, it may cause electric shock or fire. Do not place heavy objects on top of this machine.
- If you place heavy objects on the machine, the items may collapse or fall and cause injury.

Usage Notice

Periodically clean the plug and receptacle once a month and check that it is securely inserted. When you are not using the machine for a long time, please be sure to unplug the power cable from the outlet for safety.

Section 6: Warranty

1. The warranty is for one year, commencing the date the customer receives the product and includes the instrument casing, non-wearable parts, as well as, the motor and bearings. The cell culture chambers are considered consumables, Strex is responsible for repair or replacement of chambers, only if they are received and found defective.

2. The warranty does not cover damage to the instrument that is a result of the following circumstances:

- ① Damage caused by dropping, or other impact.
- ② Damage caused by inappropriate operation of the instrument.
- ③ Damage resulting from an attempted repair or modification of the instrument by the user.
- ④ Damage caused by unavoidable external causes such as earthquakes, lightening, fire, flood, gas leak, power surges, or other acts of providence.

3. Strex is free from any responsibility for effects or loss or damages arising from the result of the machine operation.

This warranty assures that Strex will repair our product free of charge as stipulated in our warranty policy. Any shipping charges will be born by buyer.

Strex US Office

10060 Carroll Canyon Rd., Suite 100

San Diego, CA 92131

Email: info@strexcell.com

www.strexcell.com

The information contained herein such as specification, configuration, and data or alike in part or in whole may be subject to change without notice.